

UPPER KNIFE

- 7641-1 Y20946
- 7641-2 20121A
- 7641-3

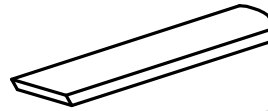

LOWER KNIFE

- 7642-2 202295(60L)
- 7642-3 A.5.8.42309(68L)
- 7642-4 118460(53L)
- 7642-5 (48L)

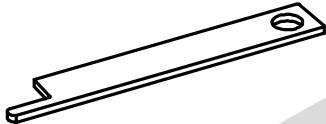

- 7643-1 PAGASIS FS 236606



- 7644-1 PAGASIS FS 236608(29L)



- 7645-1 ZUKI 34749EL(38L)

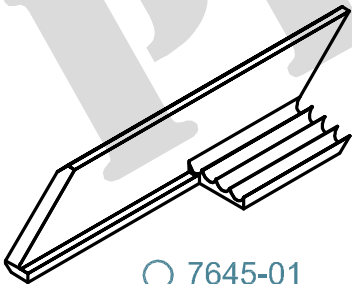

- 7645-01

ELCU

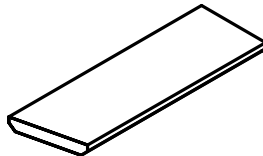

- 7646-01

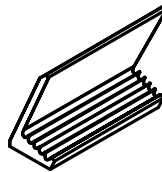

- 7645-02

MERROW

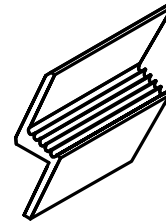

- 7645Z-02 A-90-7

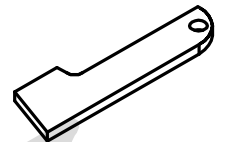

- 7646-02 6-91-K



- 7649- ZUKI

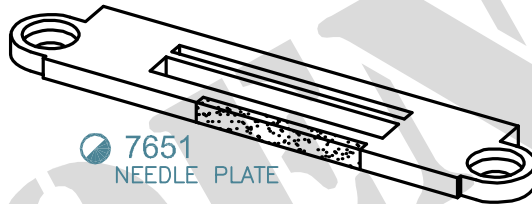

- 7651 NEEDLE PLATE

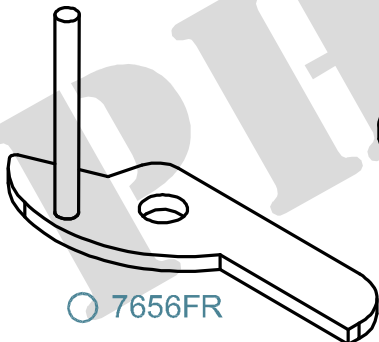

- 7656FR

VENUS

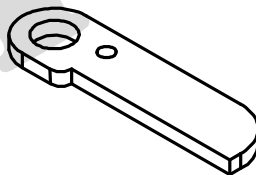

- 7656MR

MATERIAL CODE : ● SOLID CARBIDE , ○ HSS , ● BRAZED CARBIDE , ◎ TIN COATED